

- HIGH POWER
- INTEGRATED SPEED-UP DIODE

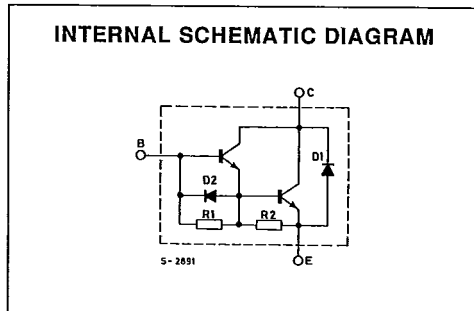
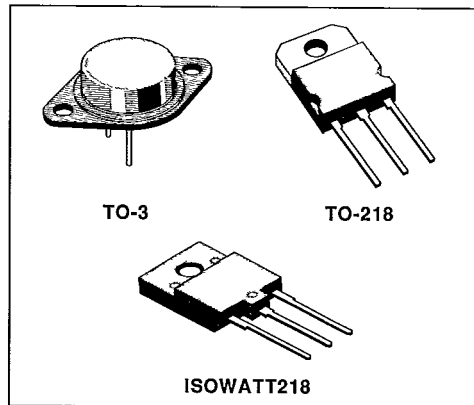

DESCRIPTION

The BUT13, BUT13P and BUT13PFI are silicon multiepitaxial planar NPN transistors in monolithic darlington configuration with integrated base-emitter speed-up diode, mounted respectively in TO-3 metal case, TO-218 plastic package and ISO-WATT218 fully isolated package.

They are particularly suited for output stages in power, fast switching applications.

ABSOLUTE MAXIMUM RATINGS

| Symbol | Parameter | Value | | | Unit |
|-----------|---|-------------|---------------|-------------------|------------------|
| V_{CBO} | Collector-base Voltage ($I_E = 0$) | 600 | | | V |
| V_{CEO} | Collector-emitter Voltage ($I_B = 0$) | 400 | | | V |
| V_{EBO} | Emitter-base Voltage ($I_C = 0$) | 10 | | | V |
| I_C | Collector Current | 28 | | | A |
| I_{CM} | Collector Peak Current | 35 | | | A |
| I_B | Base Current | 6 | | | A |
| | | TO-3 | TO-218 | ISOWATT218 | |
| P_{tot} | Total Dissipation at $T_o < 25^\circ\text{C}$ | 175 | 125 | 60 | W |
| T_{stg} | Storage Temperature | - 65 to 200 | - 65 to 150 | - 65 to 150 | $^\circ\text{C}$ |
| T_j | Max. Operating Junction Temperature | 200 | 150 | 150 | $^\circ\text{C}$ |

THERMAL DATA

| | | TO-3 | TO-218 | ISOWATT218 | |
|------------------|--------------------------------------|------|--------|------------|------|
| $R_{th(j-case)}$ | Thermal Resistance Junction-case Max | 1 | 1 | 2.08 | °C/W |

T-33-15

ELECTRICAL CHARACTERISTICS ($T_{case} = 25\text{ °C}$ unless otherwise specified)

| Symbol | Parameter | Test Conditions | Min. | Typ. | Max. | Unit |
|------------------|--|--|--|--|-------------------------|-------------------------|
| I_{CEV} | Collector Cutoff Current | $V_{CE} = 600\text{ V}$ $V_{CE} = 600\text{ V}$ $T_{case} = 100\text{ °C}$ | | | 100 2 | μA mA |
| I_{CEO} | Collector Cutoff Current ($I_B = 0$) | $V_{CE} = 400\text{ V}$ | | | 1 | mA |
| I_{EBO} | Emitter Cutoff Current ($I_C = 0$) | $V_{EB} = 2\text{ V}$ | | | 20 | mA |
| $V_{CEO(sus)}^*$ | Collector-emitter Sustaining Voltage | $I_C = 100\text{ mA}$ | 400 | | | V |
| $V_{CE(sat)}^*$ | Collector-emitter Saturation Voltage | $I_C = 10\text{ A}$ $I_C = 18\text{ A}$ $I_C = 22\text{ A}$ $I_C = 28\text{ A}$ | | $I_B = 0.5\text{ A}$ $I_B = 1.8\text{ A}$ $I_B = 2.2\text{ A}$ $I_B = 5.6\text{ A}$ | 1.3 1.7 2 2.35 | 2 2.5 3 5 V |
| $V_{BE(sat)}^*$ | Base-emitter Saturation Voltage | $I_C = 10\text{ A}$ $I_C = 18\text{ A}$ $I_C = 22\text{ A}$ | | $I_B = 0.5\text{ A}$ $I_B = 1.8\text{ A}$ $I_B = 2.2\text{ A}$ | 2.5 2.5 | 2.5 3 3.3 V |
| h_{FE}^* | DC Current Gain | $I_C = 10\text{ A}$ $I_C = 18\text{ A}$ | $V_{CE} = 5\text{ V}$ $V_{CE} = 5\text{ V}$ | 30 30 | 300 90 | |
| V_F^* | Diode Forward Voltage | $I_F = 22\text{ A}$ | | 2.2 | 4 | V |

RESISTIVE SWITCHING TIMES

| Symbol | Parameter | Test Conditions | Min. | Typ. | Max. | Unit |
|----------|--------------|--|------|------|------|---------------|
| t_{on} | Turn-on Time | $V_{CC} = 250\text{ V}$ $I_C = 10\text{ A}$ | | 0.5 | 0.6 | μs |
| t_s | Storage Time | $I_{B1} = 0.5\text{ A}$ | | 1.1 | 1.5 | μs |
| t_f | Fall Time | $V_{BE(off)} = -5\text{ V}$ | | 0.3 | 0.6 | μs |

INDUCTIVE SWITCHING TIMES

| Symbol | Parameter | Test Conditions | Min. | Typ. | Max. | Unit |
|--------|----------------|---|------|------|------|---------------|
| t_s | Storage Time | $V_{clamp} = 250\text{ V}$ $I_{B1} = 0.2\text{ A}$; | | 1.3 | 2 | μs |
| t_f | Fall Time | $I_C = 10\text{ A}$ $V_{BE(off)} = -5\text{ V}$ | | 0.11 | 0.5 | μs |
| t_c | Crossover Time | | | 0.4 | 0.8 | μs |
| t_s | Storage Time | $V_{clamp} = 250\text{ V}$ $I_{B1} = 0.4\text{ A}$; | | 1.4 | 2.6 | μs |
| t_f | Fall Time | $I_C = 20\text{ A}$ $V_{BE(off)} = -5\text{ V}$ | | 0.4 | 0.7 | μs |
| t_c | Crossover Time | | | 0.8 | 1.5 | μs |

* Pulsed : pulse duration = 300 μs , duty cycle = 1.5 %.

Safe Operating Areas (for BUT13).

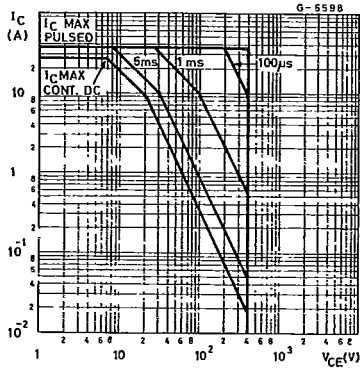

DC Current Gain.

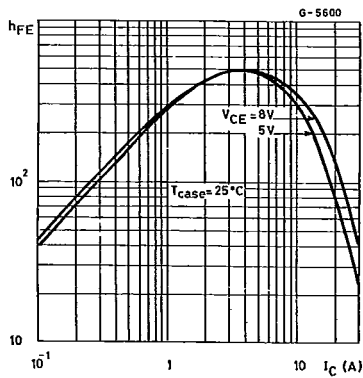

Collector-emitter Saturation Voltage.

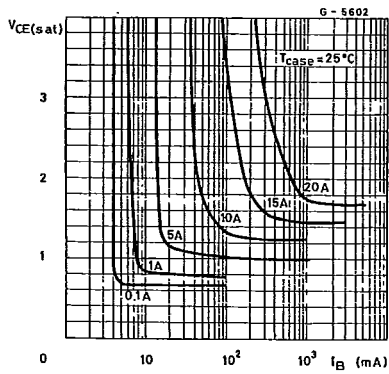

Safe Operating Areas (for BUT13P and BUT13PFI).

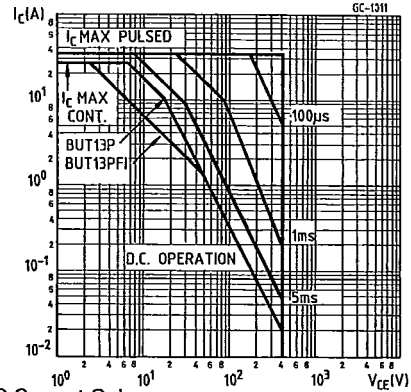

DC Current Gain.

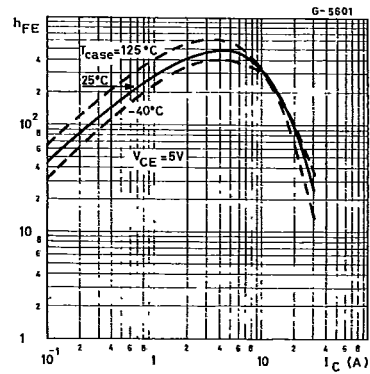

Collector-emitter Saturation Voltage.

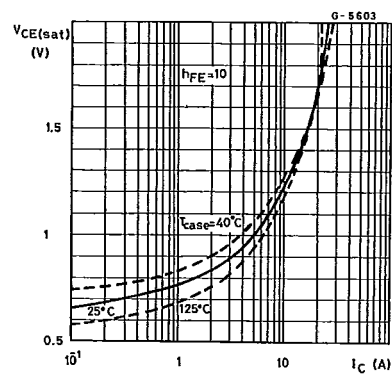

SGS-THOMSON

30E D

Base-emitter Saturation Voltage.

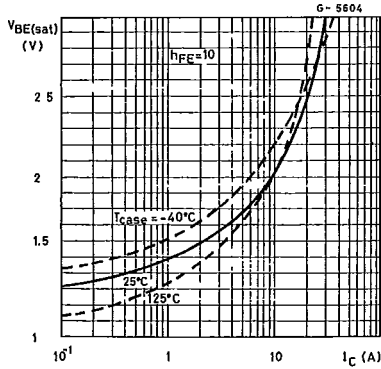

Freewheel Diode Forward Voltage.

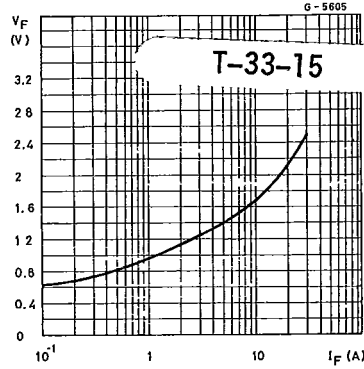

Collector-emitter Saturation Voltage Dynamic.

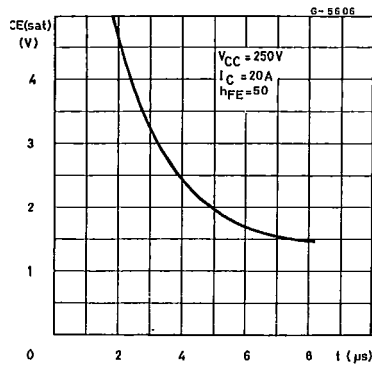

Switching Times Resistive Load (test circuit fig. 1).

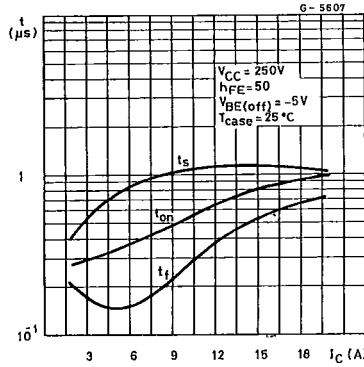

Switching Times Percentage Variation vs. Tcase.

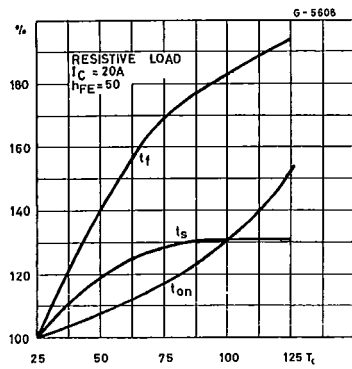

Switching Times Inductive Load Test (test circuit fig. 1).

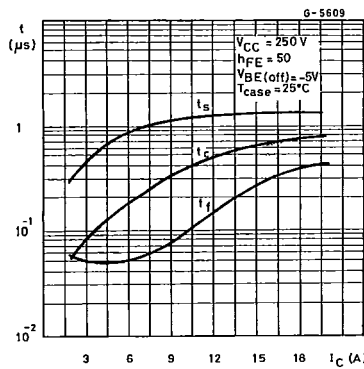

S G S-THOMSON

30E D

Switching Times Percentage Variation vs. T_{case} .

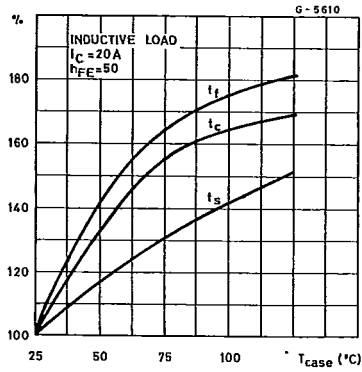

Clamped Reverse Bias Safe Operating Area.

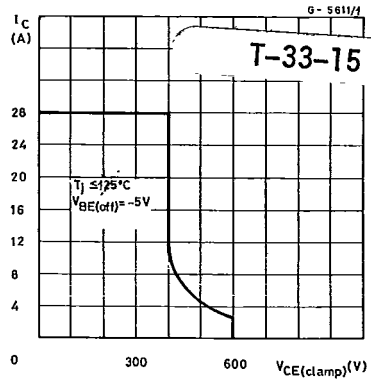

TEST CIRCUITS S G S-THOMSON

30E D

Figure 1.

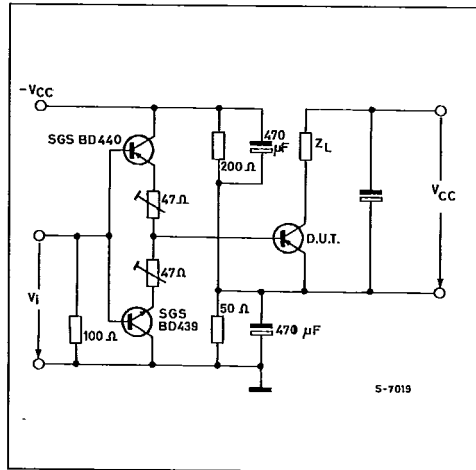

ISOWATT218 PACKAGE CHARACTERISTICS AND APPLICATION

ISOWATT218 is fully isolated to 4000V dc. Its thermal impedance, given in the data sheet, is optimized to give efficient thermal conduction together with excellent electrical isolation.

The structure of the case ensures optimum distances between the pins and heatsink. These distances are in agreement with VDE and UL creepage and clearance standards. The ISOWATT218 package eliminates the need for external isolation so reducing fixing hardware.

The package is supplied with leads longer than the standard TO-218 to allow easy mounting on pcbs.

Accurate moulding techniques used in manufacture assures consistent heat spreader-to-heatsink capacitance.

ISOWATT218 thermal performance is equivalent to that of the standard part, mounted with a 0.1mm mica washer.

The thermally conductive plastic has a higher breakdown rating and is less fragile than mica or plastic sheets. Power derating for ISOWATT218 packages is determined by :

$$P_D = \frac{T_J - T_C}{R_{th}}$$

THERMAL IMPEDANCE OF ISOWATT218 PACKAGE

Figure 2 illustrates the elements contributing to the thermal resistance of a transistor heatsink assembly, using ISOWATT218 package.

The total thermal resistance $R_{th(tot)}$ is the sum of each of these elements.

The transient thermal impedance, Z_{th} for different pulse durations can be estimated as follows :

1-For a short duration power pulse of less than 1ms :
 $Z_{th} < R_{thJ-c}$

2-For an intermediate power pulse of 5ms to 50ms seconds :

$$Z_{th} = R_{thJ-c}$$

3-For long power pulses of the order of 500ms seconds or greater :

$$Z_{th} = R_{thJ-c} + R_{thC-HS} + R_{thHS-amb}$$

It is often possible to discern these areas on transient thermal impedance curves.

Figure 2.

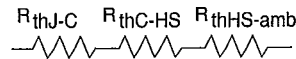

SGS-THOMSON

30E D